

- NOTES
- ⊗ : ELECTROLYTIC CONDENSER
 - ⊙ : CERAMIC CONDENSER
 - : FLAT CABLE CONNECTOR 40P
 - : SV CONNECTOR 2P
 - JP1: 2764
 - JP2: 27128
 - JP4:

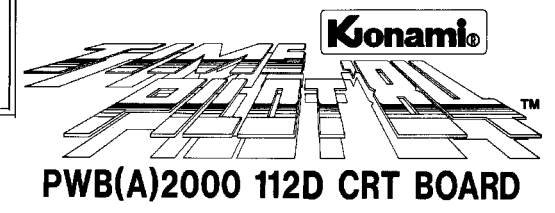

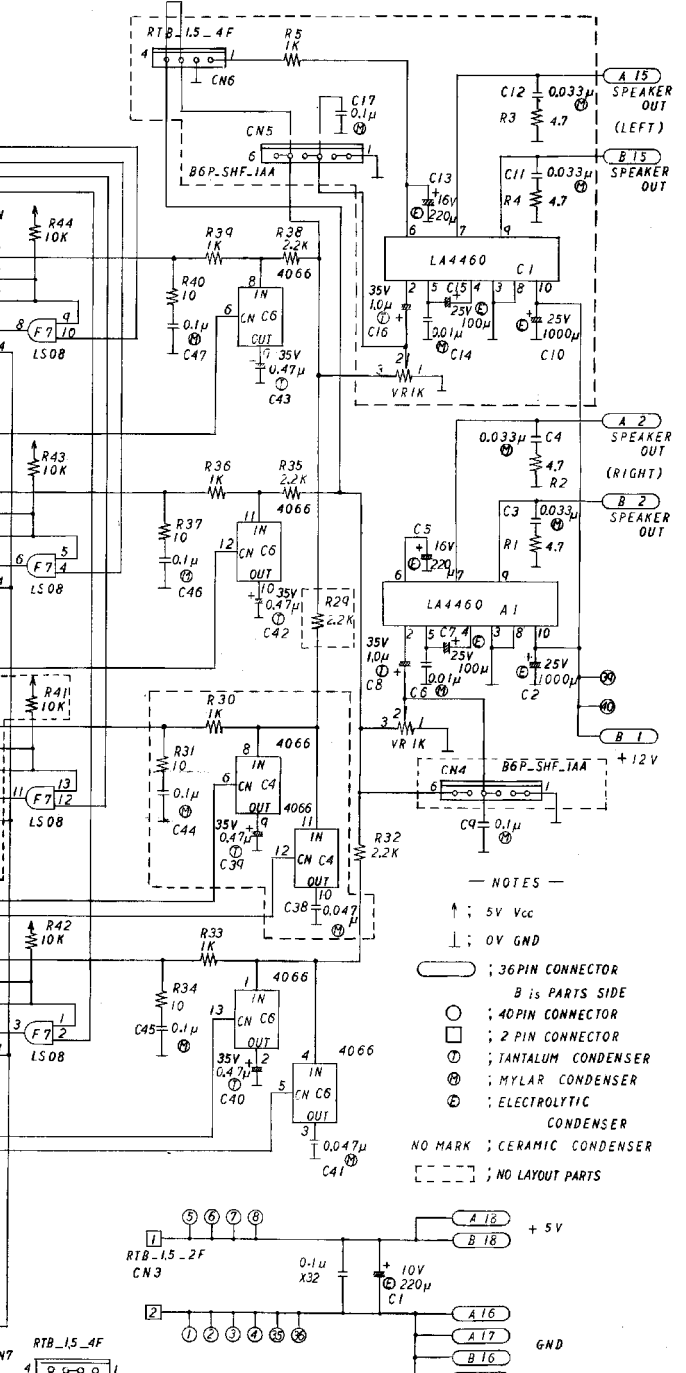

- NOTES
- ↑ : 5V Vcc
 - ↓ : 0V GND
 - : 36PIN CONNECTOR
 - : B is PARTS SIDE
 - : 40PIN CONNECTOR
 - : 2 PIN CONNECTOR
 - : TANTALUM CONDENSER
 - ⊗ : MYLAR CONDENSER
 - ⊕ : ELECTROLYTIC CONDENSER
 - NO MARK : CERAMIC CONDENSER
 - : NO LAYOUT PARTS

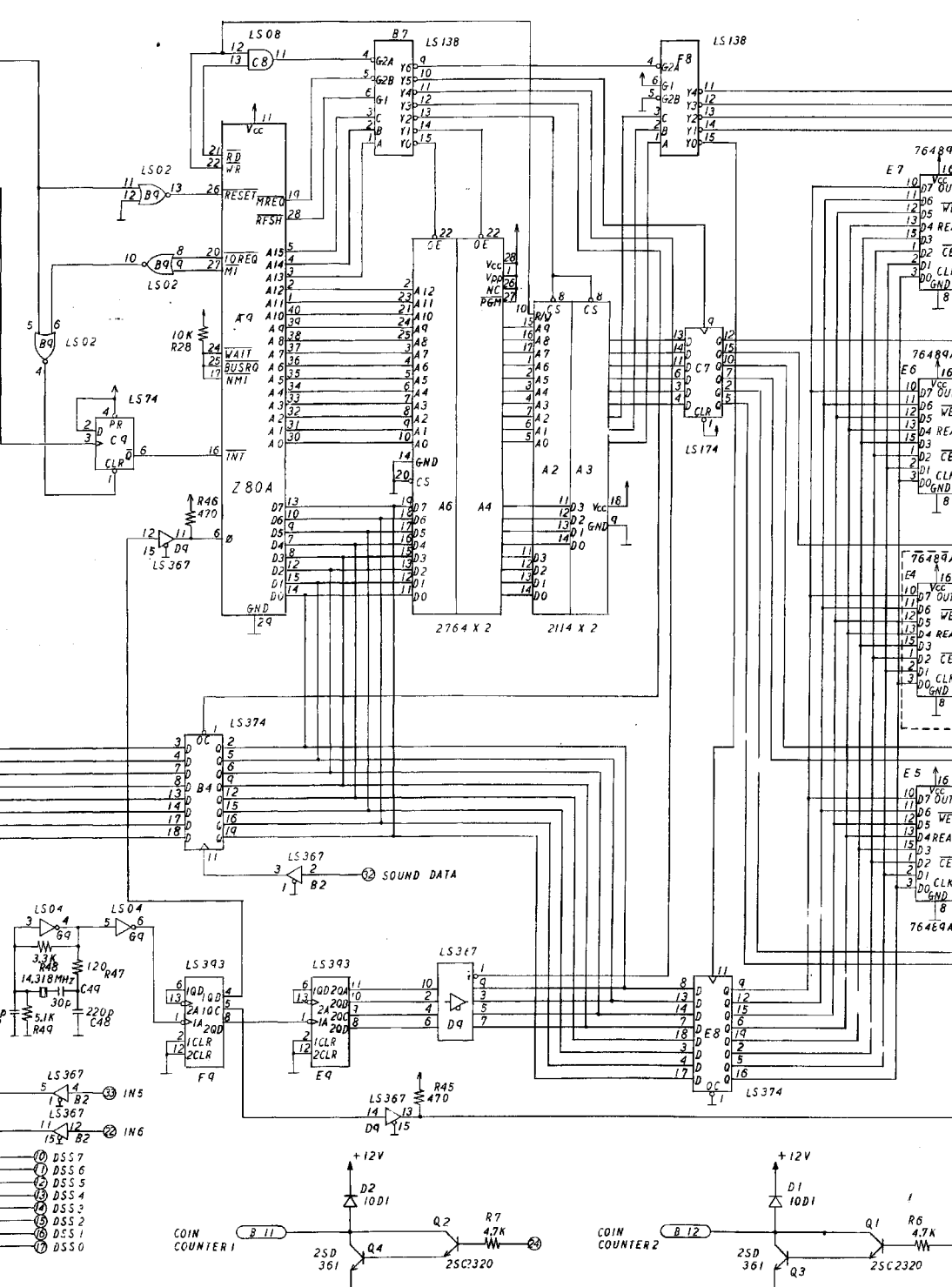
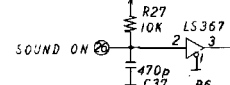
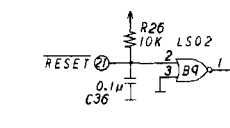
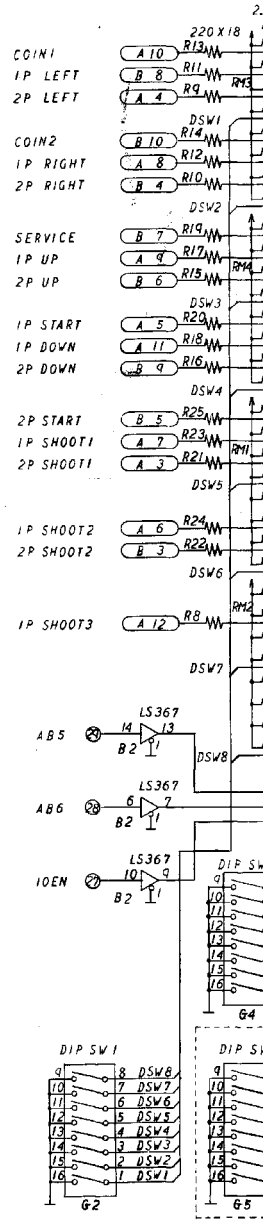
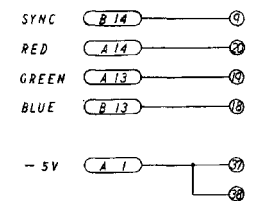
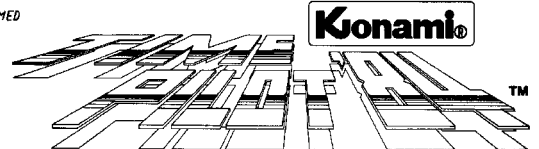
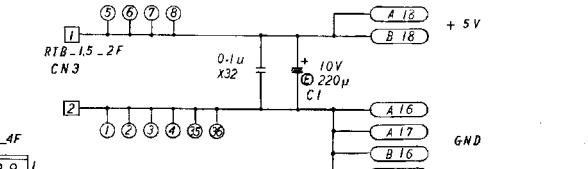
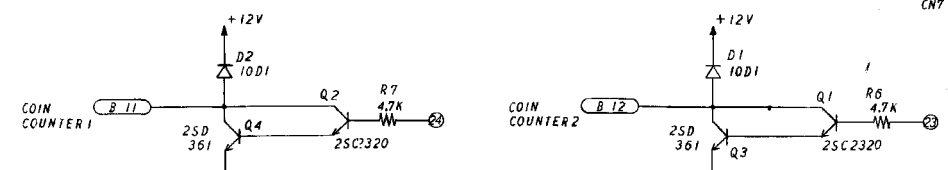

PWB(B)3000 157B SOUND BOARD

